



SILVERSTONE[®]
Designing Inspiration



SST-MFP52B

The all powerful SideShow device

Manual

SilverStone MFP52B Sideshow Unlimited Installation Guide



ENGLISH

Table of contents

Turning on	P2
Turning off	P2
Wake from standby	P2
Charging	P2
Buzzer on/off	P2
Bluetooth connect	P2
Uploading music and photos	P6
Gadgets	P8
Key Lock	P9
Basic Debugging	P9

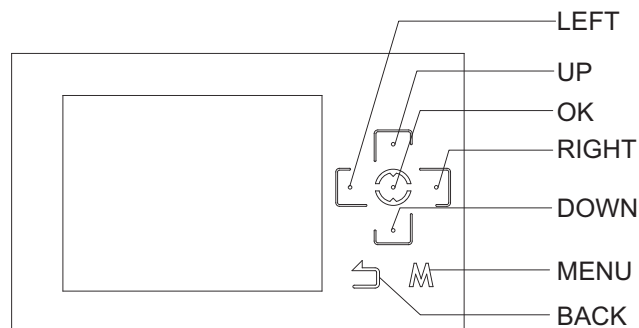

SilverStone MFP52B Sideshow Unlimited Installation Guide



1. Turning on

Touch and hold up, down, left, right, or OK for three seconds

2. Turning off

Touch and hold OK for three seconds

3. Wake from standby

Touch any key

4. Charging

With the computer turned on, plug the included USB cable into MFP52B and the computer to charge from computer's USB port (+5V)

5. Buzzer ON/OFF

With MFP52B turned on, touch and hold back for three seconds

6. Bluetooth connect

System requirement: Windows Vista, SideShow Platform, Microsoft Bluetooth Utility, Bluetooth receiver or dongle/dock (included), Sideshow SPP Profile

1. Insert Bluetooth dongle/dock into available USB port or turn on integrated Bluetooth connection
- 2. Open Microsoft Bluetooth Utility (From control panel)
- 3. Click "add" to add new device



SilverStone MFP52B Sideshow Unlimited Installation Guide



- ❖ 4. From MFP52B's main menu, choose:
Bluetooth Connect



- ❖ 5. Select Pairing Mode
(To enable automatic search for MFP52B)



- 6. Check to confirm MFP52B is ready for pairing,
then click next in Bluetooth installation wizard



■ Execute commands in Windows

❖ Execute commands on MFP52

SilverStone MFP52B Sideshow Unlimited Installation Guide



7. Select the correct Bluetooth Device (may show up as "NVIDIA Preface device"), then click next.



8. If pairing code is required, the default code is: 0000



9. Wait until the computer finishes installing Sideshow device driver, then click finish



Execute commands in Windows

Execute commands on MFP52

SilverStone MFP52B Sideshow Unlimited Installation Guide



- ❖ 10. From MFP52B, touch OK to confirm (be sure step 9 is completed first)

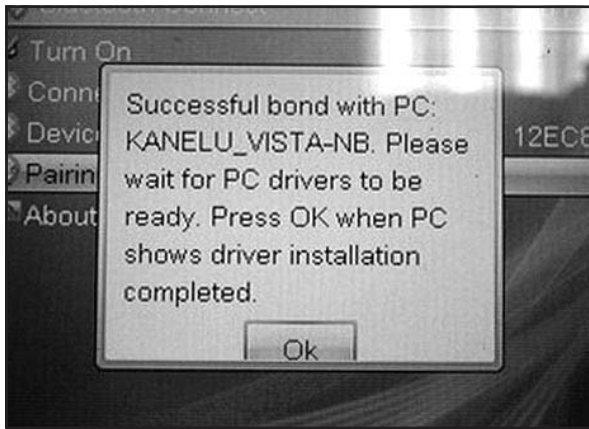

- ❖ 11. From the MFP52B's main menu, touch menu to select user (your computer's name)

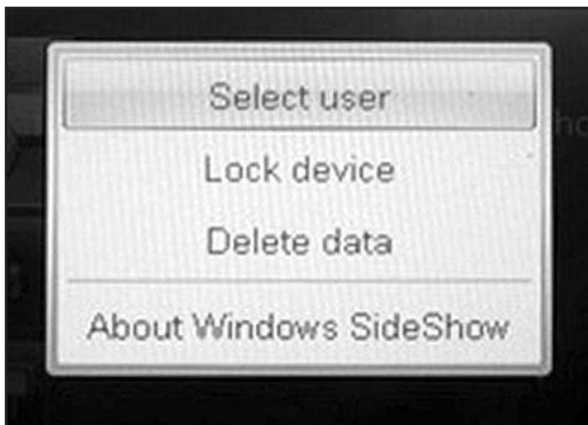

- ❖ 12. Bluetooth connect complete (MFP52B's main menu should be showing your computer's name and Bluetooth connection status)



■ Execute commands in Windows

❖ Execute commands on MFP52

SilverStone MFP52B Sideshow Unlimited Installation Guide

7. Uploading music and photos

System requirement: Windows Media Player 10 or above
(Windows XP and Vista)

1. From MFP52B's main menu, select "Music Player"



2. Select "Switch to Media Sync"



3. Sync mode should now be activated



SilverStone MFP52B Sideshow Unlimited Installation Guide



- 4. Connect the MFP52B to your computer with the included USB cable. Windows will detect a new device (such as "NVIDIA device") and automatically install the necessary drivers for it. When Windows notifies device is ready to be used, open Windows Media Player. A new portable media device (such as "NVIDIA M705 5024") will show up in a small window on the right side of Windows Media Player or in the root menu on the left side



- 5. Music and photos can be dragged and dropped into the portable media device window, when ready to upload the selected files, click on "Start Sync"



SilverStone MFP52B Sideshow Unlimited Installation Guide

❖ 6. After syncing is completed, choose cancel from the MFP52B



❑ 8. Gadgets

1. From control panel, double click on "Windows SideShow" icon



❑ 2. Check the Gadgets to be installed (Make sure the sideshow device is enabled)



❑ Execute commands in Windows

❖ Execute commands on MFP52

SilverStone MFP52B Sideshow Unlimited Installation Guide



3. Click on the Sideshow device icon to adjust additional MFP52B settings



9. Key Lock

From MFP52B's main menu, touch menu key to select "Lock device" option, then touch OK. To unlock, touch the keys in the same order

10. Basic Debugging

1. Touch key not responding

Solution: Touch and hold OK for about 13 seconds to trigger hardware reset, then the device will turn off automatically. Turning it back on again should return the device to normal. This process can be used to solve most stability problems.

2. Gadgets cannot be checked

Solution: 1. Make sure from the MFP52B, the right user is selected (please refer to Bluetooth connect instruction above)

2. Make sure the selected Gadget is designed to work with sideshow device (please check with Gadget creator/maker)

3. Bluetooth cannot connect (after pairing)

Solution: 1. Double check to make sure MFP52B and your computer is paired

2. You may have exceeded the operating range (Bluetooth class 2's typical distance is 10 meters)

3. From the MFP52B's main menu, choose "Bluetooth Connect Gadget", uncheck "BT Turn On" option, then re-check it again to reset Bluetooth connection

4. Reboot MFP52B

5. Remove/uninstall the paired devices from your computer's Bluetooth device list, then pair the MFP52B again



DEUTSCH

Inhaltsverzeichnis

Einschalten	P11
Ausschalten	P11
Wake from standby	P11
Aufladen	P11
Lautsprecher ein/auf	P11
Bluetooth Verbindung	P11
Hochladen von Musik und Bildern	P15
Gadgets	P17
Tastensperre	P18
Problembhebung	P18

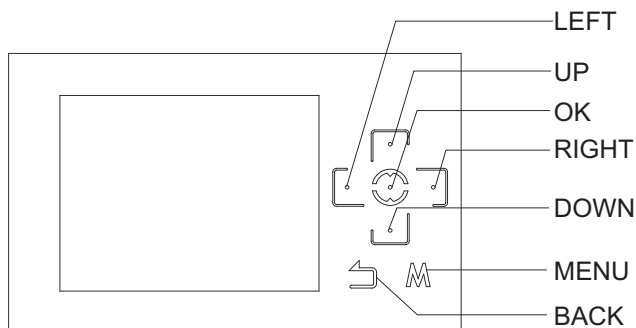

SilverStone MFP52B Sideshow Unlimited Installations-Handbuch



1. Einschalten

Halten Sie die oben, unten, links, rechts oder OK Taste für 3 Sekunden

2. Ausschalten

Halten Sie die OK Taste für 3 Sekunden gedrückt

3. Standby beenden

Berühren Sie eine beliebige Taste

4. Aufladen

Schließen Sie das Gerät an dem USB Kabel an während Ihr Computer läuft um das Gerät über den USB Port des Computers (+5V) aufzuladen

5. Lautsprecher ein/aus

Halten Sie die Zurück-Taste für 3 Sekunden gehalten während der MFP52B läuft

6. Bluetooth Verbindung

System Voraussetzungen: Windows Vista, SideShow Platform, Microsoft Bluetooth Utility, Bluetooth Empfänger oder Dongle/Dock (liegt bei), Sideshow SPP Profil

1. Stecken Sie den Bluetooth Dongle/Dock in einen verfügbaren USB Port oder schalten Sie einen vorhandenen integrierten Bluetooth Anschluss ein

■ 2. Öffnen Sie das Microsoft Bluetooth Utility (Aus der Systemsteuerung)

■ 3. Klicken Sie "hinzufügen" um ein neues Gerät hinzuzufügen



■ Execute commands in Windows ■ Execute commands on MFP52



- ❖ 4. Wählen Sie „Bluetooth Verbindung“ vom Hauptmenü des MFP52B



- ❖ 5. Wählen Sie „Paarungs-Modus“
(um die automatische Verbindungssuche des MFP52B einzuschalten)



- 6. Überprüfen Sie ob der MFP52B verbindungsbereit ist und klicken Sie dann “weiter” im Bluetooth Installations-Wizard



SilverStone MFP52B Sideshow Unlimited Installations-Handbuch

7. Wählen Sie das richtige Bluetooth Gerät aus
(wird wahrscheinlich als "NVIDIA Preface device" angezeigt)



8. Falls ein Verbindungs-Code erforderlich sein sollte, lautet dieser 0000



9. Warten Sie bis der Computer mit dem Installieren der Sideshow
Gerätetreiber fertig ist und klicken sie dann auf „Fertigstellen“



Execute commands in Windows

Execute commands on MFP52



- ❖ 10. Berühren Sie die OK Taste auf dem Display des MFP52B um die Verbindung zu bestätigen (stellen Sie sicher das Schritt 9 zuvor abgeschlossen wurde)

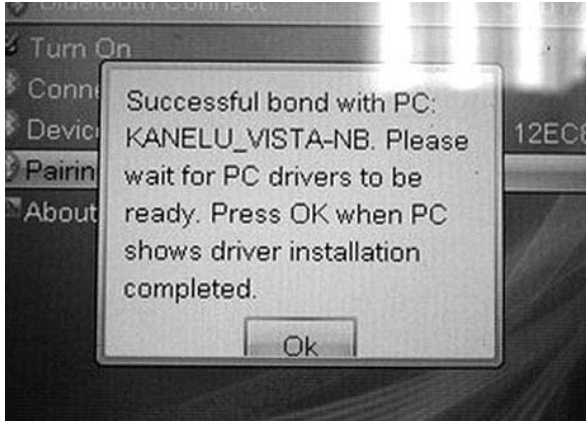

- ❖ 11. Wählen Sie aus dem Hauptmenü des MFP52B „Menü" um eine Benutzer auszuwählen (der Name Ihres Computers)

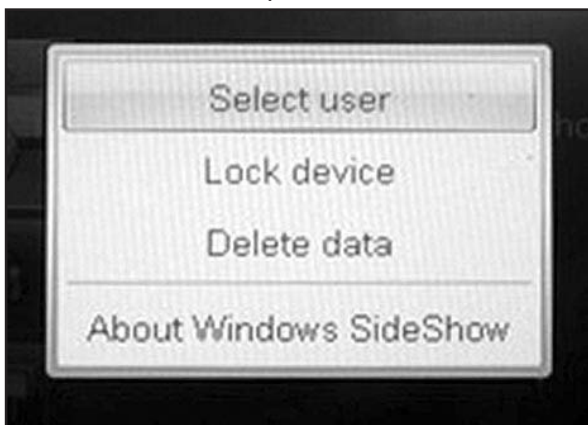

- ❖ 12. Bluetooth Verbindung hergestellt
(Im MFP52B Hauptmenü sollte der Name Ihres Computers und der Status der Bluetooth Verbindung angezeigt werden)





7. Hochladen von Musik und Bildern

System Voraussetzungen: Windows Media Player 10 oder höher
(Windows XP und Vista)

1. Wählen Sie „Musik Wiedergabe“ vom Hauptmenü des MFP52B



2. Wählen Sie “Wechsel zu Medien-Synchronisation”



3. Synchronisations-Modus sollte jetzt aktiviert sein



SilverStone MFP52B Sideshow Unlimited Installations-Handbuch



- 4. Verwenden Sie das beiliegende USB Kabel um den MFP52B mit Ihrem PC zu verbinden. Windows wird das neue Gerät automatisch erkennen (beispielsweise als „NVIDIA Gerät“) und automatisch die notwendigen Treiber für das Gerät installieren. Öffnen Sie den Media Player nachdem Windows mitgeteilt hat dass das Gerät verwendet werden kann. Es wird ein neuer Wechseldatenträger (beispielsweise als “NVIDIA M705 5024“) in einem kleinen Fenster auf der rechten Seite des Media Players angezeigt.



- 5. Musik und Bilder können mittels Drag-and-Drop in das Fenster des Wechseldatenträgers gezogen werden. Klicken Sie auf „Synchronisation starten“ wenn Sie bereit sind die ausgewählten Dateien auf das Gerät zu übertragen



SilverStone MFP52B Sideshow Unlimited Installations-Handbuch



- ❖ 6. Wählen Sie “abbrechen” auf dem MFP52B nachdem die Übertragung abgeschlossen ist



■ 8. Gadgets

1. Gehen Sie in die Systemsteuerung und machen Sie einen Doppelklick auf das “Windows SideShow” Icon



- 2. Wählen Sie die zu installierenden Gadgets aus (Stellen Sie sicher dass das Sideshow-Gerät verfügbar ist)



Execute commands in Windows Execute commands on MFP52



3. Klicken Sie auf das Icon des Sideshow Gerätes um weitere Einstellungen am MFP52B vorzunehmen



9. Tastensperre

Wählen Sie aus dem Hauptmenü des MFP52B "Menü" um dort die Option "Tastensperre" auszuwählen, berühren Sie anschließend die OK Taste. Um die Tastensperre aufzuheben, berühren Sie die Tasten in der gleichen Reihenfolge

10. Problembhebung

1. Tasten reagieren nicht bei Berührung

Lösung: Berühren Sie die OK Taste und halten Sie diese für 13 Sekunden gedrückt um einen Hardware-Reset auszulösen. Das Gerät wird sich automatisch ausschalten. Bei erneutem Einschalten sollte das Gerät wieder normal funktionieren. Dieser Vorgang kann die meisten Stabilitätsprobleme lösen.

2. Gadgets können nicht ausgewählt werden

Lösung: 1. Stellen Sie sicher das auf dem MFP52B der richtige Nutzer ausgewählt ist (siehe "Bluetooth Verbindung")

2. Stellen Sie sicher dass das ausgewählte Gadget mit Sideshow-Geräten verwendet werden kann (überprüfen Sie dies mit dem Gadget Creator/Maker)

3. Bluetooth Verbindung fehlgeschlagen (nach Paarung)

Lösung: 1. Überprüfen Sie ob der MFP52B und der Computer gepaart sind

2. Es könnte sein dass Sie zu weit entfernt sind (Bluetooth Klasse 2 hat eine Reichweite von ca. 10 Metern)

3. Wählen Sie aus dem Hauptmenü des MFP52B "Bluetooth Verbindungs-Gadget", demarkieren Sie die Option "BT Turn On" und wählen Sie die Option dann erneut aus um einen Reset der Bluetooth Verbindung vorzunehmen

4. Führen Sie einen Reboot des MFP52B durch

5. Entfernen Sie die gepaarten Geräte aus der Bluetooth Liste Ihres Computers und paaren Sie den MFP52B anschließend erneut

SilverStone MFP52B Sideshow Unlimited Guide d'installation



FRANCAIS

Sommaire

Démarrage	P20
Extinction	P20
Réveil	P20
Chargement	P20
Buzzer on/off	P20
Connexion Bluetooth	P20
Chargement de musiques et photos	P24
Gadgets	P26
Vérouillage des touches	P27
Dépannage	P27

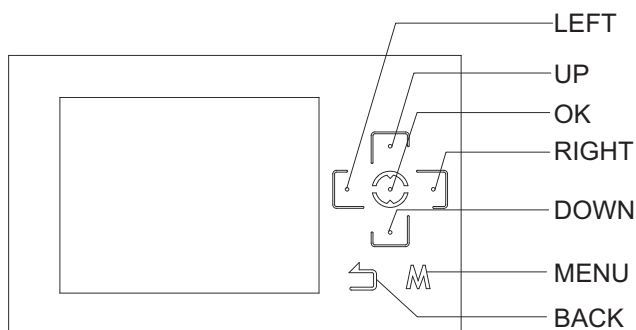

SilverStone MFP52B Sideshow Unlimited Guide d'installation



1. Démarrage

Appuyez pendant 3 secondes sur un des boutons suivants : haut, bas, gauche, droite ou OK

2. Extinction

Appuyez pendant 3 secondes sur le bouton OK

3. Réveil

Appuyez sur n'importe quel bouton

4. Rechargement

Avec l'ordinateur démarré, branchez le câble USB entre le MFP52B et l'ordinateur pour commencer le rechargement à partir du port USB (+5V) de l'ordinateur

5. Buzzer ON/OFF

Avec le MFP52B allumé, appuyez pendant 3 secondes sur le bouton retour

6. Connexion Bluetooth

Besoins système : Windows Vista, Plateforme SideShow, Utilitaire Microsoft Bluetooth, Recepteur Bluetooth ou dongle/dock (inclus), Sideshow SPP Profile

1. Insérez le dongle/dock Bluetooth dans un port USB disponible ou démarrez une connexion Bluetooth si elle est intégré

■ 2. Ouvrez l'utilitaire Bluetooth de Microsoft (à partir du panneau de configuration)

■ 3. Cliquez sur "Ajouter" pour ajouter un nouvel appareil



■ Execute commands in Windows ■ Execute commands on MFP52

SilverStone MFP52B Sideshow Unlimited Guide d'installation



- ❖ 4. A partir du menu principal du MFP52B, choisissez:
Bluetooth Connect



- ❖ 5. Sélectionnez Pairing Mode
(Pour permettre la recherche automatique du MFP52B)



- 6. Vérifiez que le MFP52B est prêt pour le jumelage, puis cliquez sur suivant dans l'interface d'installation Bluetooth



SilverStone MFP52B Sideshow Unlimited Guide d'installation

7. Sélectionnez le bon appareil Bluetooth (probablement affiché comme "NVIDIA Preface device"), puis cliquez sur suivant



8. Si un code de jumelage est requis, le code par défaut est : 0000



9. Attendez que l'ordinateur finisse d'installer le pilote de l'appareil Sideshow, puis cliquez sur Terminer



SilverStone MFP52B Sideshow Unlimited Guide d'installation



- ❖ 10. Sur le MFP52B, appuyez sur le bouton OK pour confirmer
(D'abord vérifiez bien que l'étape 9 est bien terminée)

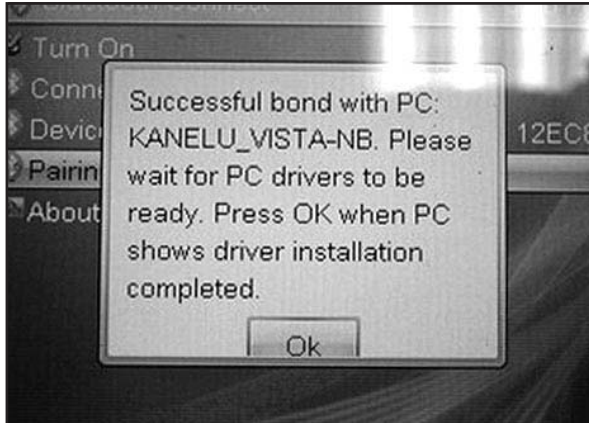

- ❖ 11. Sur le menu principal du MFP52B, appuyez sur menu pour sélectionner l'utilisateur (le nom de votre ordinateur)

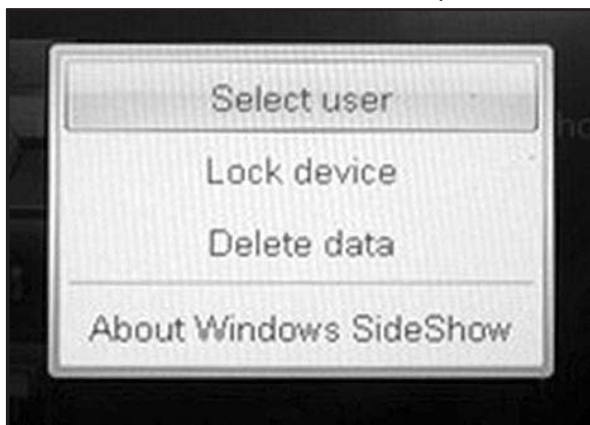

- ❖ 12. La connexion Bluetooth se termine
(L'écran principal du MFP52B doit vous montrer le nom de votre ordinateur et le statut de la connexion Bluetooth)



■ Execute commands in Windows

❖ Execute commands on MFP52

7. Chargement de musiques et photos

Besoins système : Windows Media Player 10 ou supérieur
(Windows XP et Vista)

- ☒ 1. Sur l'écran principal du MFP52B, sélectionnez "Music Player"



- ☒ 2. Sélectionnez "Switch to Media Sync"



- ☒ 3. Le mode Sync (Synhronisé) doit maintenant être activé



SilverStone MFP52B Sideshow Unlimited Guide d'installation



- 4. Branchez le MFP52B sur votre ordinateur avec le câble USB inclus. Windows détectera un nouvel appareil (comme par exemple "NVIDIA device") et installera automatiquement les pilotes nécessaires. Lorsque Windows vous notifiera que l'appareil est prêt à être utilisé, ouvrez Windows Media Player. Un nouvel appareil portable (comme "NVIDIA M705 5024") sera montré dans une petite fenêtre sur le côté droit de Windows Media Player ou dans le menu principal sur le côté gauche



- 5. Les musiques et les photos peuvent être glissées/déposées dans la fenêtre de l'appareil portable, lorsque vous êtes prêt pour le transfert des fichiers sélectionnés, cliquez sur "Start Sync" (Démarrer synchronisation)



SilverStone MFP52B Sideshow Unlimited Guide d'installation



6. Après que la synchronisation soit terminée, choisissez Annuler sur le MFP52B



8. Gadgets

1. A partir du panneau de configuration, double cliquez sur l'icône "Windows SideShow"



2. Vérifiez que les gadgets sont bien installés (Vérifiez également que l'appareil sideshow est activé)



Execute commands in Windows Execute commands on MFP52

SilverStone MFP52B Sideshow Unlimited Guide d'installation



3. Cliquez sur l'icône de l'appareil Sideshow pour régler les paramètres additionnels du MFP52B



9. Verrouillage des touches

A partir du menu principal du MFP52B, appuyez sur le bouton menu pour sélectionner l'option "Lock device", puis appuyez sur OK. Pour déverrouiller, appuyez sur les touches dans le même ordre

10. Dépannage

1. Touches ne répondant pas

Solution: Appuyer sur la touche OK pendant environ 13 secondes pour déclencher une réinitialisation de l'appareil, puis l'appareil s'éteindra automatiquement.

Rallumez-le et il devrait fonctionner normalement. Ce procédé peut solutionner la plupart des problèmes de stabilité.

2. Les Gadgets ne peuvent pas être vérifiés

Solution: 1. Vérifiez sur le MFP52B que le bon utilisateur est sélectionné (Veuillez vous référer aux instructions de connexion Bluetooth ci-dessus)

2. Vérifiez que le Gadget sélectionné a bien été conçu pour fonctionner avec les appareils sideshow(veuillez vérifier avec le créateur/fabricant du gadget)

3. Le Bluetooth ne pas se connecter (après jumelage)

Solution: 1. Vérifiez deux fois que le MFP52B et votre ordinateur sont bien jumelés

2. Vous avez peut être dépassé la distance d'utilisation (La distance des appareils Bluetooth de 2eme classe est typiquement de 10 mètres)

3. Sur le menu principal du MFP52B, choisissez "Bluetooth Connect Gadget", décochez l'option "BT Turn On", puis recochez la pour réinitialiser la connexion Bluetooth

4. Redémarrez le MFP52B

5. Retirez/désinstallez les appareils jumelés de votre liste d'appareils Bluetooth de votre ordinateur, puis re-jumelé votre MFP52B une nouvelle fois

SilverStone MFP52B Sideshow Unlimited

Guía de instalación



ESPAÑOL

Contenido

Encendiendo	P29
Apagando	P29
Prender de espera	P29
Cargar	P29
Zumbador Encender/Apagar	P29
Conectar Bluetooth	P29
Subir música y fotos	P33
Gadgets	P35
Bloquear tecla	P36
Eliminar errores	P36

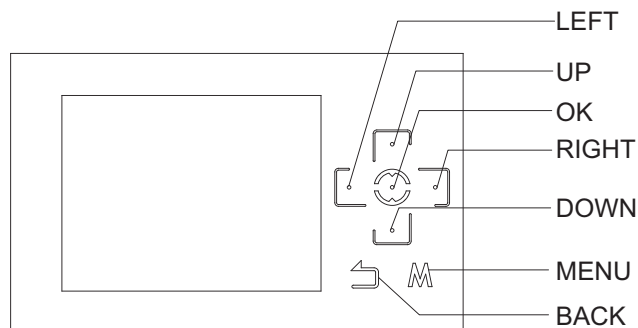

SilverStone MFP52B Sideshow Unlimited

Guía de instalación



1. Encendiendo

Toque y sostenga, abajo, izquierdo, derecho, u OK por tres segundos

2. Apagando

Toque y sostenga OK por tres segundos

3. Prender de Espera

Toque cualquier llave

4. Cargar

Con la computadora encendida, conecte el cable incluido del USB en MFP52B y la computadora para cargar del puerto del USB de la computadora (+5V)

5. Zumbador Encender/Apagar

Con el MFP52B encendido, toque y sostenga por tres segundos

6. Conectar Bluetooth

Requisito del sistema: Windows Vista, Plataforma de SideShow, utilidad de Microsoft Bluetooth, receptor o dongle de Bluetooth/dock (incluido), Perfil de Sideshow SPP

1. Inserte el dongle/dock de Bluetooth en el puerto disponible del USB o encienda la conexión integrada de Bluetooth
2. Abra la utilidad de Microsoft Bluetooth (del panel de control)
3. Clic “agregar” para agregar el nuevo dispositivo



Execute commands in Windows Execute commands on MFP52

SilverStone MFP52B Sideshow Unlimited

Guía de instalación



- ❖ 4. Del menú principal de MFP52B, elija:
Conectar Bluetooth



- ❖ 5. Seleccione Modo de apareamiento
(Para permitir la búsqueda automática para MFP52B)



- 6. Revise para confirmar MFP52B es listo para aparearse, después clic Niguyente en el Wizard de la instalación de Bluetooth



■ Execute commands in Windows

❖ Execute commands on MFP52

SilverStone MFP52B Sideshow Unlimited

Guía de instalación



7. Seleccione el dispositivo correcto de Bluetooth (puede demostrar como “dispositivo del prefacio de NVIDIA”), después clic Siguiente



8. Si se requiere el apareamiento de código, el código de defecto es: 0000



9. Espere hasta que la computadora acabe de instalar el Controlador de dispositivo de Sideshow, entonces clic finalizar



SilverStone MFP52B Sideshow Unlimited

Guía de instalación



- ❖ 10. De MFP52B, toque OK para confirmar
(sea seguro que el paso 9 está terminado primero)

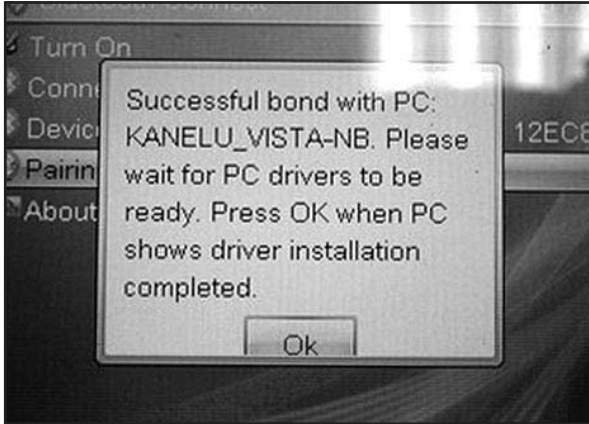

- ❖ 11. Del menú principal de MFP52B, toque el menú para seleccionar a usuario
(su nombre de computadora)

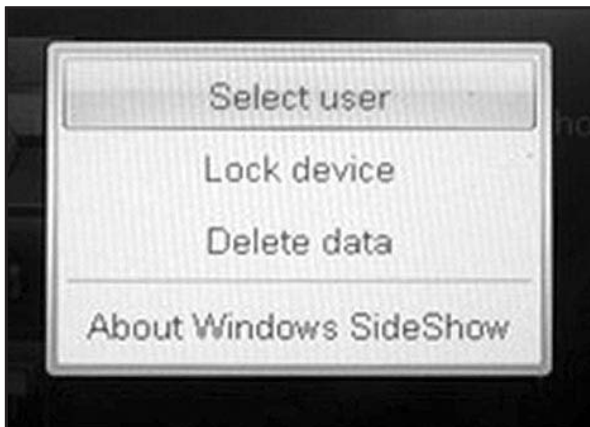

- ❖ 12. Conectar Bluetooth completo
(El menú principal de MFP52B debe demostrar su estado del nombre de computadora y de la conexión de Bluetooth)



❑ Execute commands in Windows

❖ Execute commands on MFP52



7. Subir Música y Fotos

Requisito del sistema: Windows Media Player 10 o superior
(Windows XP y Vista)

1. Menú principal de MFP52B, seleccione a “Music Player”



2. Seleccione “Switch to Media Sync”



3. Modo de sync ahora debe ser activado



SilverStone MFP52B Sideshow Unlimited

Guía de instalación



- 4. Conecte el MFP52B con su computadora con el cable incluido del USB. Windows detectará un nuevo dispositivo (tal como “dispositivo de NVIDIA”) e instalará automáticamente los controladores necesarios para él. Cuando Windows notifica el dispositivo es listo ser utilizado, abra Windows Media Player. Un nuevo dispositivo portable de media (tal como “NVIDIA M705 5024”) demostrará arriba en una ventana pequeña en lado derecho del Windows Media Player o en del lado izquierdo del menú raíz



- 5. La música y las fotos pueden ser arrastradas y tiradas en la ventana portable del dispositivo de medios, cuando es listo de subir los archivos seleccionados, clic en “start sync”



SilverStone MFP52B Sideshow Unlimited

Guía de instalación



6. Después de que syncing se finalice, elija cancelar del MFP52B



8. Gadgets

1. Del panel de control, doble clic en el icono de "Windows SideShow"



2. Revise los gadgets que se instalarán

(Asegurese de que el dispositivo del sideshow esté permitido)



Execute commands in Windows

Execute commands on MFP52

SilverStone MFP52B Sideshow Unlimited

Guía de instalación



3. Clic en el icono del dispositivo de Sideshow para ajustar ajustes adicionales de MFP52B



9. Bloquear tecla

Del menú principal de MFP52B, toque la tecla menú para seleccionar opción “Bloquear dispositivo”, entonces toque OK. Para abrir, toque las teclas en la misma orden

10. Eliminar errores

1. Tecla del tacto no responde

Solución: Toque y sostenga OK por cerca de 13 segundos para accionar reajuste del hardware, entonces el dispositivo se apaga automáticamente. Para encenderlo de nuevo debe volver otra vez el dispositivo al normal. Este proceso se puede utilizar para solucionar la mayoría de los problemas de la estabilidad.

2. Los gadgets no pueden ser comprobados

Solución: 1. Asegurese de que MFP52B, se selecciona el usuario adecuado (por favor refiera a la instrucción de conectar Bluetooth arriba)
2. Asegurese de que el gadget seleccionado esté diseñado para trabajar con el dispositivo del sideshow (por favor revise con el Gadget creator/maker)

3. Bluetooth no puede conectar (después de aparear)

Solución: 1. Revise con detalle para asegurarse de que MFP52B y su computadora está apareado
2. Usted pudo haber excedido del rango de operación (la distancia típica de Bluetooth clase 2 es de 10 metros)
3. Del menú principal de MFP52B, elija “Bluetooth Connect Gadget”, quite la opción “BT turn on”, después vuelva a revisar para reajustar la conexión de Bluetooth
4. Reanude el MFP52B
5. Quite/desinstale los dispositivos apareados de la lista de dispositivo de Bluetooth de su computadora, después aparee el MFP52B otra vez

SilverStone MFP52B Sideshow Unlimited

Guida all'installazione



ITALIANO

Indice

Accensione	P38
Spegnimento	P38
Sblocco stand-by	P38
Carica	P38
Suoneria on/off	P38
Connessione Bluetooth	P38
Upload di musica e foto	P42
Dispositivi	P44
Blocca tastiera	P45
Basic Debugging	P45

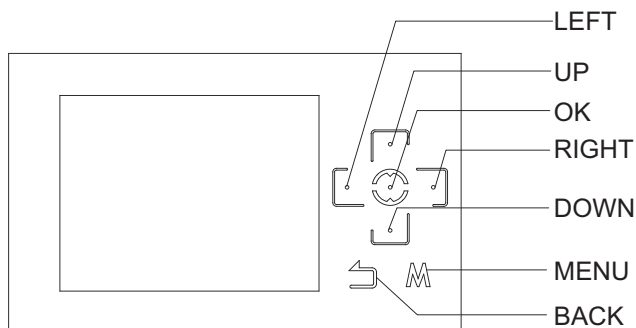

SilverStone MFP52B Sideshow Unlimited

Guida all'installazione



1. Accensione

Toccare e tenere premuta la parte superiore, inferiore, sinistra, destra o OK per tre secondi

2. Spegnimento

Toccare e tenere premuto OK per tre secondi

3. Sblocco stand-by

Toccare un tasto qualsiasi

4. Carica

Con il computer acceso, inserire il cavo USB incluso nel MFP52B e nel computer per caricare dal porto USB del computer (+5V)

5. Suoneria ON/OFF

Con L'MFP 52B acceso, toccare e tenere premuto per tre secondi

6. Connessione bluetooth

Requisiti del sistema: Windows Vista, SideShow Platform, Microsoft Bluetooth Utility, Bluetooth receiver o dongle/dock (incluso), Sideshow SPP Profile

1. Inserire il dongle/ dock del Bluetooth in un porto USB disponibile o accendere la connessione integrata Bluetooth

❑ 2. Aprire il Bluetooth utility di Microsoft (dal pannello di controllo)

❑ 3. Cliccare su "add" per aggiungere un nuovo dispositivo.



❑ Execute commands in Windows ❑ Execute commands on MFP52

SilverStone MFP52B Sideshow Unlimited Guida all'installazione



- ❖ 4. Scegliere dal menu principale dell'MFP52B:
Bluetooth Connect



- ❖ 5. Selezionare Pairing Mode
(Per attivare la ricerca automatica dell' MFP52B)



- 6. Assicurarsi che l'MFP52B sia pronto per il pairing e cliccare quindi su
Bluetooth installation wizard



■ Execute commands in Windows

❖ Execute commands on MFP52

SilverStone MFP52B Sideshow Unlimited Guida all'installazione

7. Selezionare il dispositivo Bluetooth corretto (potrebbe mostrarsi come "NVIDIA Preface device"), quindi cliccare su next



8. Se fosse necessario inserire il codice pairing il codice default è: 0000



9. Aspettare che il computer termini il sideshow dell'installazione del dispositivo, quindi cliccare su finish



SilverStone MFP52B Sideshow Unlimited Guida all'installazione



- ❖ 10. Dall'MFP52B, premere su OK per confermare
(assicurarsi che il procedimento 9 sia stato completato)

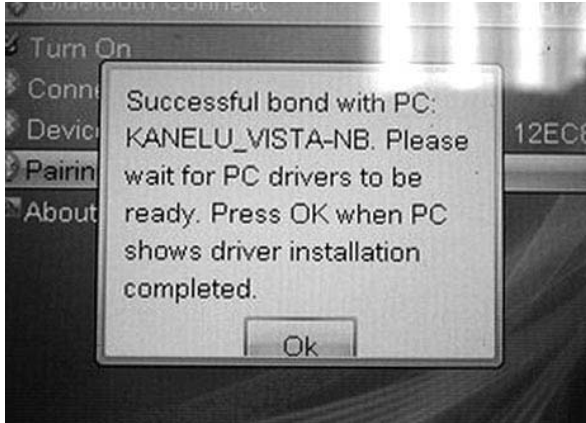

- ❖ 11. dal menu principale dell' MFP52B, premere menu per selezionare l'utente
(select user - il nome del Suo computer)

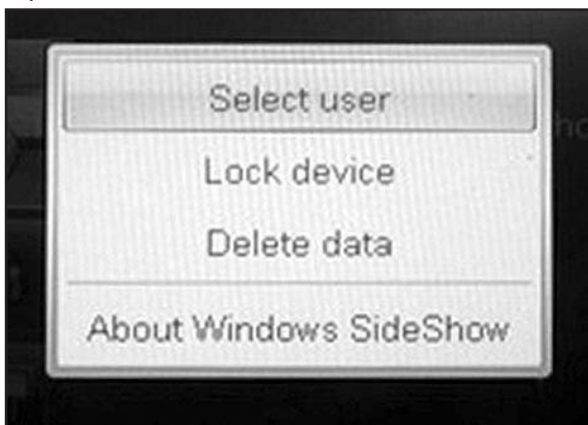

- ❖ 12. Connessione Bluetooth completa
(Il menu principale dell'MFP52B dovrebbe mostrare il nome del Suo computer e lo status della connessione Bluetooth)



■ Execute commands in Windows

❖ Execute commands on MFP52

7. Upload di musica e foto

Requisiti del sistema: Windows Media Player 10 o successivi
(Windows XP e Vista)

1. Dal menu principale dell' MFP52B selezionare "Music Player"



2. Selezionare "Switch to Media Sync"



3. Il Sync mode non deve essere attivato



SilverStone MFP52B Sideshow Unlimited Guida all'installazione



- 4. Connettere l'MFP52B al computer con il cavo USB incluso. Windows rileverà il nuovo dispositivo(come "NVIDIA device") ed installerà automaticamente i drivers per esso necessari. Quando windows comunica che il dispositivo è pronto per l'uso, aprire windows media player. Apparirà una piccola finestra al lato destro di windows media player a nel menu root a sinistra con un nuovo dispositivo portatile (come "NVIDIA M705 5024")



- 5. Musica e foto possono essere trascinate ed inserite nella finestra del dispositivo portatile. Quando si è pronti a caricare i file selezionati, cliccare su "start Sync"



SilverStone MFP52B Sideshow Unlimited Guida all'installazione

6. Dopo aver completato la sincronizzazione scegliere cancel dall'MFP52



8. Dispositivi

1. Dal pannello di controllo, fare doppio click su “ Windows SideShow”



2. Controllare i dispositivi che devono essere installati (assicurarsi che il SideShow sia attivato)



Execute commands in Windows Execute commands on MFP52

SilverStone MFP52B Sideshow Unlimited

Guida all'installazione



3. Clickare sull'icona del dispositivo Sideshow per regolare le ulteriori impostazioni dell'MFP52B



9. Blocco tastiera

Dal menu principale dell' MFP52B's selezionare l'opzione "Lock device", quindi toccare OK. Per sbloccare, toccare i tasti nello stesso ordine.

10. Basic

Debugging

1. Se si preme un tasto non succede niente

Soluzione: Toccare e tenere premuto OK per circa 13 secondi per avviare il reset dell'hardware, quindi il dispositivo si spegnerà automaticamente. Dopo aver riavvicinato il dispositivo di nuovo dovrebbe funzionare tutto regolarmente. Questo processo può essere usato per risolvere la maggior parte dei problemi di stabilità

2. Il dispositivo non può essere scelto

Soluzione: 1. Assicurarsi che sia stato selezionato l'utente giusto dall' MFP52B, (consultare le istruzioni di connessione Bluetooth menzionate sopra).
2. Assicurarsi che il dispositivo selezionato sia adatto per il funzionamento con il \ dispositivo sideshow device (Consultare il produttore del dispositivo)

3. Impossibilità di connettersi a Bluetooth (dopo il pairing)

Soluzione: 1. Assicurarsi che tra l'MFP52B il computer sia stato effettuato il pairing
2. È possibile che il campo operativo sia eccessivo (La distanza tipica del Bluetooth di 2 classe è 10m)
3. Dal menu principale dell' MFP52B's scegliere Bluetooth connect Gadget", disattivare la funzione "BT Turn On" e riattivarla di nuovo per ristabilire la connessione Bluetooth.
4. Fare il reboot dell'MFP52B
5. Deinstallare il dispositivo a cui è stato fatto il pairing con la lista dei dispositivi Bluetooth del computer, quindi fare il pairing dell'MFP52B di nuovo.

SilverStone MFP52B Sideshow Unlimited

Инструкция по установке



русский

Содержание

Включение	P47
Выключение	P47
Выход из спящего режима	P47
Зарядка	P47
Включение/выключение зуммера	P47
Подключение Bluetooth	P47
Загрузка музыки и фотографий	P51
Гаджеты	P53
Блокировка	P54
Устранение неисправностей	P54

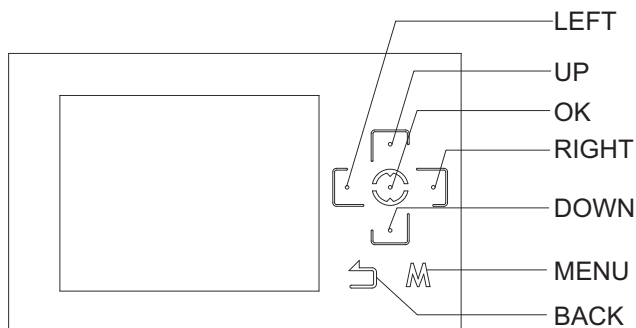

SilverStone MFP52B Sideshow Unlimited

Инструкция по установке



1. Включение

Коснитесь и удерживайте "up", "down", "left", "right" или "OK" в течение трех секунд

2. Выключение

Коснитесь и удерживайте "OK" в течение трех секунд

3. Выход из спящего режима

Коснитесь любой клавиши

4. Зарядка

Для зарядки от USB-порта компьютера (+5 В) подсоедините прилагаемый USB-кабель к MFP52B и включенному компьютеру

5. Включение/выключение зуммера

При включенном MFP52B коснитесь и удерживайте "back" в течение трех секунд

6. Подключение Bluetooth

Системные требования: Windows Vista, SideShow Platform, Microsoft Bluetooth Utility, Bluetooth-приемник или донгл/док (в комплекте), SideShow SPP Profile

1. Вставьте Bluetooth-донгл/док в USB-порт или включите встроенное Bluetooth-соединение.

❑ 2. Откройте Microsoft Bluetooth Utility (через панель управления).

❑ 3. Нажмите "Добавить" ("add") для добавления нового устройства.



❑ Execute commands in Windows

❑ Execute commands on MFP52

SilverStone MFP52B Sideshow Unlimited

Инструкция по установке



- ❖ 4. В главном меню MFP52B выберите "Подключение Bluetooth" ("Bluetooth Connect")



- ❖ 5. Выберите режим парного соединения ("Pairing Mode") (для включения автоматического поиска MFP52B)



- 6. Убедитесь, что MFP52B находится в режиме парного соединения, затем нажмите "Далее" ("next") в Мастере настройки Bluetooth (Bluetooth installation wizard)



SilverStone MFP52B Sideshow Unlimited

Инструкция по установке



7. Выберите нужное Bluetooth-устройство (отображаемое как "NVIDIA Preface device"), затем нажмите "Далее" ("next")



8. Если необходим режим парного соединения, код по умолчанию: 0000



9. Дождитесь окончания установки драйвера SideShow-устройства, затем нажмите "Завершить" ("finish")



Execute commands in Windows

Execute commands on MFP52

SilverStone MFP52B Sideshow Unlimited

Инструкция по установке



- ❖ 10. В MFP52B коснитесь "OK" для подтверждения (перед этим убедитесь, что этап 9 завершен)

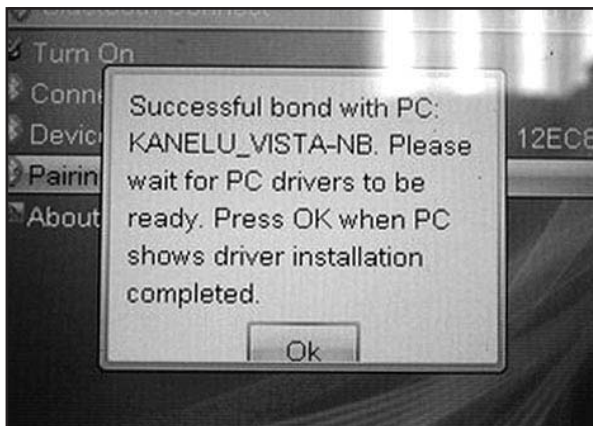

- ❖ 11. В главном меню MFP52B выберите пользователя (имя вашего компьютера)

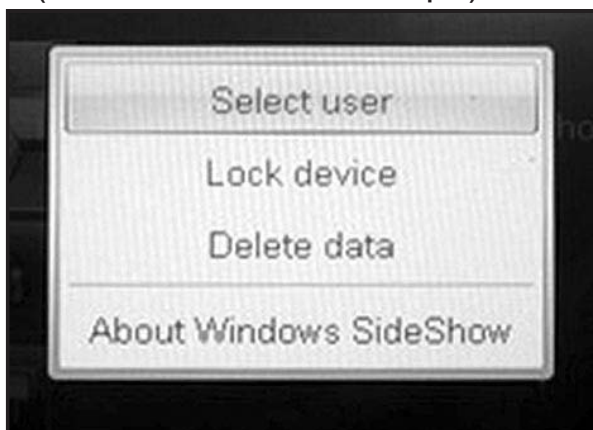

- ❖ 12. Подключение Bluetooth завершено. (В главном меню MFP52B должно отображаться имя вашего компьютера и статус Bluetooth-соединения.)



7. Загрузка музыки и фотографий

Системные требования: Windows Media Player 10 или выше
(Windows XP и Vista)

- ❖ 1. В главном меню MFP52B выберите "Музыкальный плеер" ("Music Player")



- ❖ 2. Выберите "Перейти в режим синхронизации" ("Switch to Media Sync")



- ❖ 3. Теперь должен быть активирован режим синхронизации



SilverStone MFP52B Sideshow Unlimited

Инструкция по установке



- 4. Подключите MFP52B к Вашему компьютеру с помощью прилагаемого USB-кабеля. Windows обнаружит новое устройство ("NVIDIA device") и автоматически установит нужные драйвера. Когда Windows сообщит, что устройство готово к работе, откройте Windows Media Player. В маленьком окне в правой части Windows Media Player или в главном меню слева появится новое портативное медиаустройство ("NVIDIA M705 5024")



- 5. Перетащите музыкальные файлы и фотографии в окно портативного медиаустройства. Для загрузки выбранных файлов нажмите "Начать синхронизацию" ("Start Sync")



SilverStone MFP52B Sideshow Unlimited Инструкция по установке

❖ 6. После завершения синхронизации нажмите "Отмена" ("cancel") в MFP52B



■ 8. Гаджеты

1. Дважды нажмите на иконку "Windows SideShow" на панели управления



■ 2. Проверьте устанавливаемые гаджеты.

(Убедитесь, что SideShow-устройство активировано.)



■ Execute commands in Windows

❖ Execute commands on MFP52

SilverStone MFP52B Sideshow Unlimited

Инструкция по установке



3. Нажмите на иконку SideShow-устройства, чтобы отрегулировать дополнительные настройки MFP52B



9. Блокировка

В главном меню MFP52B выберите опцию "Заблокировать устройство" ("Lock device"), затем нажмите "OK". Для разблокировки нажмите клавиши в том же порядке

10. Устранение неисправностей

1. Сенсорная клавиша не отвечает.

Решение: Для перезагрузки коснитесь и удерживайте "OK" около 13 секунд, устройство выключится автоматически. Для нормальной работы включите его снова. Этим способом можно решить большинство проблем со стабильностью

2. Невозможно проверить гаджеты.

Решение: 1. Убедитесь, что в MFP52B пользователь выбран правильно (обратитесь к приведенной выше инструкции по подключению Bluetooth).
2. Убедитесь, что выбранный гаджет предназначен для работы с SideShow-устройством (проверьте с помощью "Gadget creator/maker").

3. Bluetooth-соединение не устанавливается (после входа в режим парного соединения).

Решение: 1. Проверьте еще раз, что MFP52B и Ваш компьютер находятся в режиме парного соединения.
2. Возможно, Вы вышли из зоны действия (расстояние для Bluetooth-соединения класса 2 – 10 метров).
3. В главном меню MFP52B выберите "Установить Bluetooth-соединение с гаджетом" ("Bluetooth Connect Gadget"), отключите опцию "BT Turn On", затем включите ее снова для возобновления Bluetooth-соединения.
4. Перезагрузите MFP52B.
5. Отключите/переустановите устройства из списка Bluetooth-устройств вашего компьютера, находящиеся в режиме парного соединения, затем снова установите парное соединение с MFP52B



한국어 목차

전원 켜기	P56
전원 끄기	P56
대기 상태에서 깨어나기	P56
충전	P56
경보음 켜기 끄기	P56
블루투스 연결	P56
음악과 사진 업로드	P60
가젯	P62
키락	P63
기본 디버깅	P63

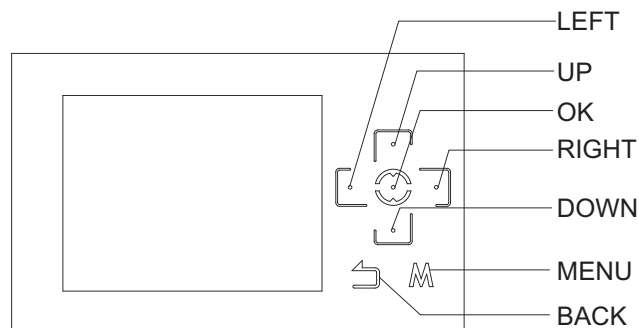



1. 전원 켜기

Up, Down, Left, Right 혹은 OK 를 3초 이상 누르십시오

2. 전원 끄기

OK를 3초동안 누르면 전원이 꺼집니다

3. 대기상태에서 깨어나기

아무 키나 누르면 대기상태에서 깨어납니다

4. 충전

컴퓨터가 켜져있는 상태에서 동봉된 USB 케이블을 MFP52B 와 컴퓨터의 USB포트에 각각 연결해 줍니다

5. 경보음 켜기 /끄기

MFP52B 가 켜져 있는 상태에서 back 키를 3초간 누르십시오

6. 블루투스 연결

시스템 요구사항 : Windows Vista, SideShow Platform, Microsoft Bluetooth Utility, Bluetooth receiver or dongle/dock (included), Sideshow SPP Profile

1. 블루투스 동글/도크를 비어있는 USB

USB 포트에 삽입하거나,
블루투스 연결을 켜십시오.

■ 2. 제어판에서 Microsoft Bluetooth Utility를
여십시오.

■ 3. 새로운 장비를 추가하기 위해 추가
단추를 누르십시오.





❖ 4. MFP52B의 메뉴에서 다음을 선택하십시오 : 블루투스 연결



❖ 5. 페어링 모드를 선택 (MFP52B 자동검색을 설정합니다.)

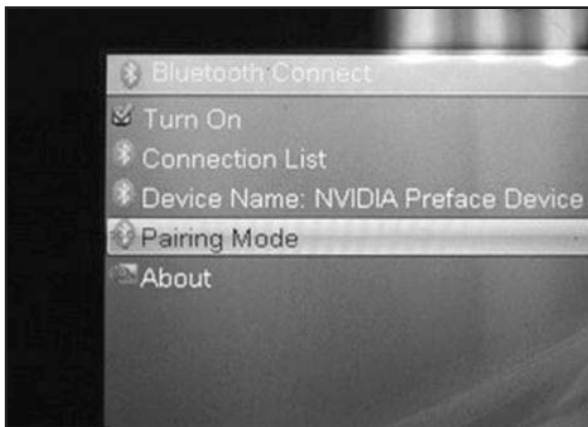

■ 6. MFP52B 페어링이 준비되어 있는지 확인하고, 블루투스 설치 마법사에서 다음을 클릭하십시오

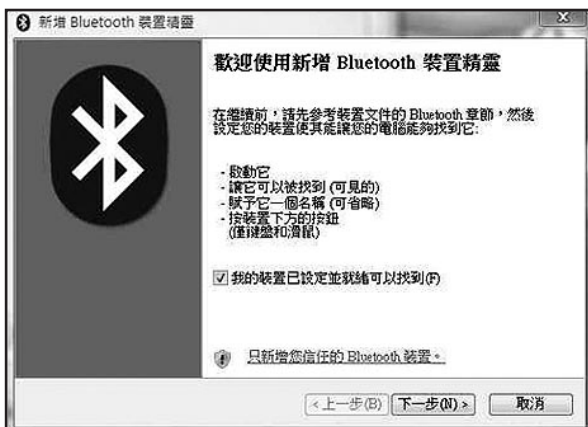

SilverStone MFP52B Sideshow Unlimited 설치 가이드



- 7. 해당하는 블루투스 디바이스를 선택하신 후
(NVIDIA Preface Device 라고 나타날 수 있습니다.) 다음을 클릭하십시오



- 8. 페어링 코드가 필요할 경우 기본 코드는 0000 입니다



- 9. Sideshow 디바이스 드라이버 설치가 끝날 때까지 기다린 후 마침을 클릭하십시오





- ❖ 10. MF52B에서 OK를 눌러 확인하십시오.
(9번이 정상적을 마쳐야 가능합니다.)

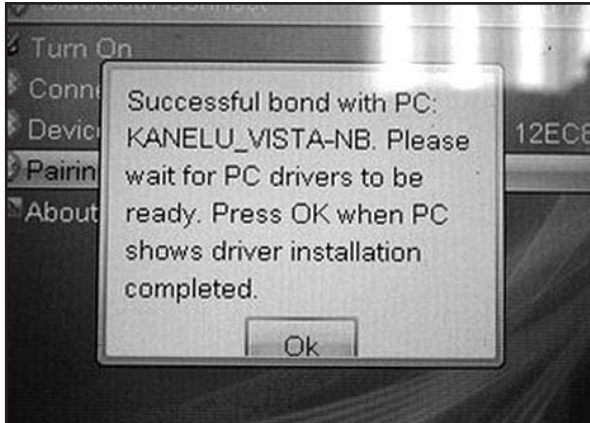

- ❖ 11. MFP52B의 메인 메뉴에서 “메뉴”를 눌러 사용자를 선택합니다.
(사용자의 컴퓨터 이름)

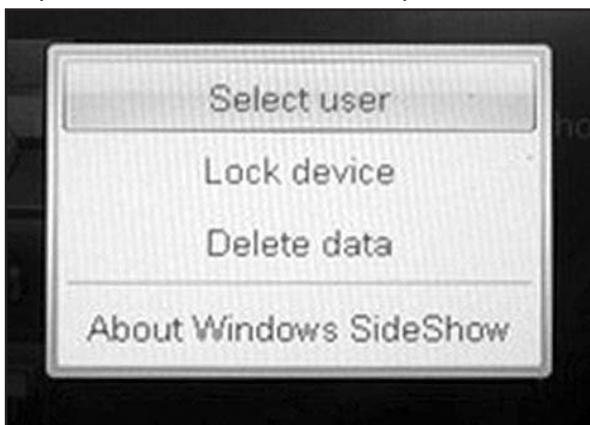

- ❖ 12. 블루투스 연결 완료
(MFP52의 메인 메뉴에서 상요자의 컴퓨터이름과 블루투스 연결 상태가 나타납니다.)



7. 음악과 사진 업로드

시스템 요구사항 : Windows Media Player 10 or above (Windows XP and Vista)

❖ 1. MFP52B의 메인 메뉴에서 “Music Player”를 선택합니다



❖ 2. “Switch to Media Sync”를 선택합니다



❖ 3. Sync Mode가 이제 활성화 되었습니다





- 4. MFP52B를 동봉된 USB 케이블을 이용해 컴퓨터와 연결하십시오. Windows는 새로운 장치(Nvidia Device)를 인식하게되며 자동으로 필요한 드라이버를 설치합니다. Windows가 장치가 사용 가능하다고 알려오면, Windows Media Player를 여십시오. 새로운 이동 미디어 디바이스("NVIDIA M705 5024")가 Windows Media Player의 오른쪽에 작은 윈도우에 나타나거나, 왼쪽의 루트 메뉴에 나타나게 됩니다



- 5. 음악과, 사진은 이동 미디어 디바이스 윈도우에 드래그 앤 드롭 방식으로 복사가능하고, 미디어 파일의 업로드가 준비되면, "Start Sync"를 클릭하십시오





6. 싱크가 완료되면, MFP52B에서 취소를 선택하십시오



8. 제어판에서

1. “Windows SideShow” 아이콘을 더블클릭합니다



2. 설치할 가젯을 선택하십시오.

(Sideshow 디바이스가 활성화 되어 있는지 확인요)



Execute commands in Windows

Execute commands on MFP52



3. Sideshow 디바이스 아이콘을 클릭해 추가로 MFP52B 설정합니다



9. 키락

MFP52B의 메인 메뉴에서 메튜키를 선택해 “Lock Device” 옵션을 선택한 후 OK를 누릅니다. 키락을 해제 하려면, 키락과 같은 순서로 진행하면 됩니다

10. 기본적인 디버깅

1. 터치기가 반응하지 않는다

해결방법 : OK를 약 13초가 눌러 하드웨어 리셋을 시작하면, 디바이스는 자동으로 꺼집니다. 다시 전원을 키면, 디바이스가 정상으로 돌아옵니다. 이 프로세스는 대부분의 안정성과 관련된 문제를 해결하는데 유용합니다

2. 가젯들이 선택되지 않는다

해결방법 1. MFP52B에서 사용자가 정확하게 선택되어 있는지 확인합니다. (위의 블루투스 연결 방법을 참조하십시오.)
2. 선택된 가젯트가 Sideshow 디바이스와 호환되는지 확인합니다. (가젯트 제작자에 확인하십시오.)

3. 블루투스 연결이 안됩니다. (페어링 이후)

해결방법 1. MFP52B와 컴퓨터가 페어링 되어 있는지 재차 확인하십시오.
2. 사용할 수 있는 범위(거리)를 벗어 났는지 확인해 주십시오. (Bluetooth Class2는 일반적으로 10m 입니다.)
3. MFP52B의 메인 메뉴에서 “ Bluetooth Connect Gadget”을 선택하신 후, “BT Turn On” 옵션을 선택 해제하고, 다시 선택해 블루투스 연결을 리셋 하십시오.
4. MFP52B를 리부팅 하십시오.
5. 컴퓨터의 블루투스 디바이스 리스트에서 페어링된 디바이스를 삭제 및 제거를 해주신 후, 다시 MFP52B를 페어링 하십시오.



日本語
目次

電源を入れる	P65
電源を切る	P65
スタンバイからのウェイク	P65
充電	P65
ブザーのオン・オフ	P65
ブルートゥース接続	P65
音楽と写真のアップロード	P69
ガジェット	P71
キーロック	P72
簡単なトラブルシューティング	P72

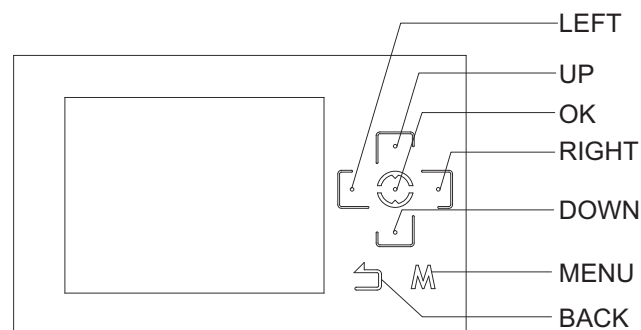

SilverStone MFP52B Sideshow Unlimited インストールガイド



1. 電源を入れる

上下左右キーまたはOKボタンを3秒間押し続けます

2. 電源を切る

OKボタンを3秒間押し続けます

3. スタンバイからのウェイク

任意のキーに触ります

4. 充電

コンピュータの電源を入れ、付属のUSBケーブルをMFP52Bおよびコンピュータに接続して、コンピュータのUSBポート (+5V)から充電します

5. ブザーのオン・オ

MFP52Bの電源を入れ、キーを3秒間押し続けます

6. ブルートゥース接続

システム要件: Windows Vista, SideShow Platform,
Microsoft ブルートゥースユーティリティ, ブルートゥースレシーバー
または dongle/ドック(付属), Sideshow SPP プロファイル

1. ブルートゥース dongle/ドックを空

いているUSBポートに挿すか、
内蔵のブルートゥース接続を有効にします。

- 2. Microsoftブルートゥースユーティリティを
起動させます。

(コントロールパネル経由で)

- 3. 「追加」をクリックして、新しいデバイスを
追加します。



■ Execute commands in Windows

⊗ Execute commands on MFP52

SilverStone MFP52B Sideshow Unlimited インストールガイド



- ❖ 4. MFP52BのメインメニューからBluetooth Connect（ブルートゥース接続）を選びます



- ❖ 5. ペ어링モードを選択します。
(これでMFP52Bの自動検知機能が有効になります)



- 6. MFP52Bがペアリングモードであることを確認して、ブルートゥースインストールウィザードの「次へ」をクリックします

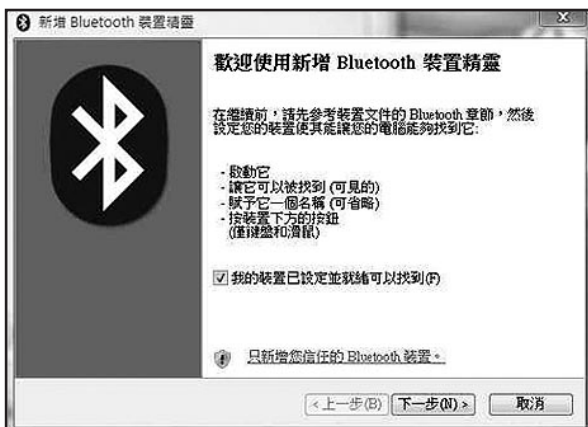

SilverStone MFP52B Sideshow Unlimited インストールガイド

- 7. 正しいBluetoothデバイス(「NVIDIAプリフェースデバイス」と表示される時あり)を選び、「次へ」をクリックします



- 8. ペ어링コードが必要であれば、デフォルトのコードは000



- 9. コンピュータへのSideshowデバイスドライバのインストール後、「完了」をクリックします



■ Execute commands in Windows

Execute commands on MFP52

SilverStone MFP52B Sideshow Unlimited インストールガイド



- ❖ 10. MFP52Bから「OK」を押して確認します。
(まずステップ9が完了していることを確認してください)

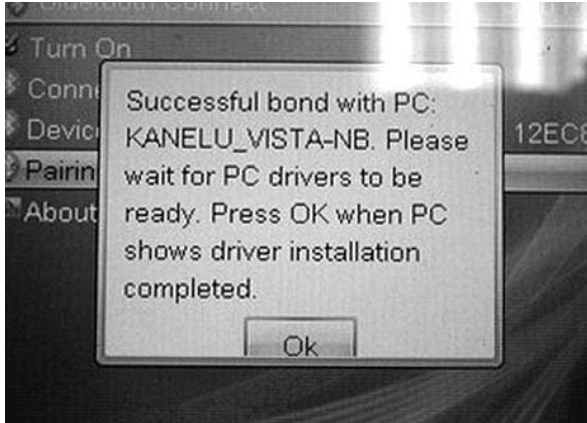

- ❖ 11. MFP52Bのメインメニューから、select user (ユーザーの選択) を選びます。
(ご使用のコンピュータ名です。)



- ❖ 12. これでブルートゥース接続が確立されました。
(MFP52Bのメインメニューには、ご使用のコンピュータ名およびブルートゥース接続の状態が表示されています。)



■ Execute commands in Windows

❖ Execute commands on MFP52

7. 音楽と写真のアップロード

システム要件: Windows Media Player 10またはそれ以降
(Windows XPおよびVista)

- ❖ 1. MFP52Bのメインメニューから、“Music Player” (ミュージックプレーヤー) を選びます



- ❖ 2. “Switch to Media Sync” (メディアの同期へのスイッチ) を選びます



- ❖ 3. 同期モードが有効になります



SilverStone MFP52B Sideshow Unlimited インストールガイド



- 4. MFP52Bを付属のUSBケーブルでコンピュータに接続します。Windowsは新しいデバイスを検知 (例: “NVIDIAデバイス”) し、必要なドライバが自動的にインストールされます。Windowsからデバイスがしようかのであることが表示されたら、Windowsメディアプレーヤーを起動させます。新しいポータブルメディアデバイス (例: “NVIDIA M705 5024”) がWindowsメディアプレーヤーの右側の小窓または左側のルートメニューに表示されます



- 5. 音楽および写真は、ポータブルメディアデバイスウィンドウにドラッグ・ドロップ可能です。指定したファイルのアップロードの準備ができたなら、“Start Sync” (同期の開始) をクリックします



SilverStone MFP52B Sideshow Unlimited インストールガイド

❖ 6.同期が完了したら、MFP52Bから「キャンセル」を選びます



❑ 8. ガジェット

1. コントロールパネルから、“Windows SideShow” アイコンをダブルクリックします



❑ 2. インストールするガジェットにチェックします。

(Sideshowデバイスが有効になっていることを確認します。)



❑ Execute commands in Windows

❖ Execute commands on MFP52

SilverStone MFP52B Sideshow Unlimited インストールガイド



■ 3. Sideshowデバイスアイコンをクリックし、MFP52Bの詳細設定を設定します



9. キーロック

MFP52Bのメインメニューから、タッチメニューキーで“Lock device”（デバイスのロック）を選び、OKを押します。ロック解除には同じ順序でキーを操作します

10. 簡単なトラブルシューティング

1. タッチキーが反応しない。

解決法：OKを13秒押し続けると、ハードウェアリセットが有効となり、デバイスが自動的にオフになります。電源を入れ直すとデバイスが正常に戻ります。この手順で安定性のトラブルの大半が解決します。

2. ガジェットにチェックできない。

解決法：1. MFP52Bから、正しいユーザーが選ばれているかチェックします。（上記のブルートゥース接続をご参照ください。）
2. 選択するガジェットがsideshowデバイスで利用可能か確認します。（ガジェットクリエイター/メーカーをご参照ください。）

3. ブルートゥースが接続できない。（ペアリング後）

解決法：1. MFP52Bとコンピュータのペアリングが確立していることを確認します。
2. 動作可能範囲を越えていないか確認します。（Bluetoothクラス2の典型値は10 mです。）
3. MFP52Bのメインメニューから、“Bluetooth Connect Gadget（ブルートゥース接続ガジェット）”を選び、“BT Turn On”オプションのチェックを外し、ブルートゥース接続を再度試します。
4. MFP52Bの電源を入れ直します。
5. コンピュータのブルートゥースデバイス一覧からペアリングのデバイスを削除/アンインストールし、MFP52Bを再度ペアリングしてみます。

Execute commands in Windows

Execute commands on MFP52



简体中文

目录

开机	P74
关机	P74
待机启动	P74
充电	P74
休眠开关	P74
蓝牙连接	P74
上传音乐与照片	P78
小工具	P79
屏幕保护锁	P81
基本错误排除	P81

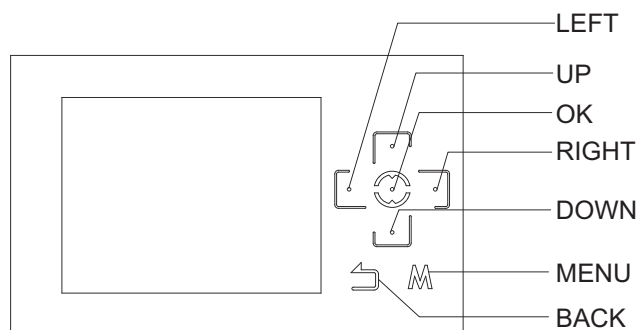



1. 开机

持续轻压上下左右或确认键三秒钟

2. 关机

持续轻压确认键三秒钟

3. 待机启动

触碰任何键

4. 充电

在计算机开机状态下，使用内附的USB连接线接上MFP52B与计算机USB端口(+5V)进行充电

5. 休眠开关

在MFP52B开机状态下，持续轻压返回键三秒

6. 连接蓝芽装置

系统需求：Windows Vista, SideShow 平台, 微软蓝芽公用程序, 蓝芽接收器或内附传输座, Sideshow SPP Profile

1. 将蓝芽接收器装入可用的USB埠，或开启整合性蓝芽连接装置

■ 2. 从控制台开启微软蓝芽公用程序

■ 3. 点击”新增”以增加新装置



■ Execute commands in Windows ⚙ Execute commands on MFP52

SilverStone MFP52B Sideshow Unlimited 安装指南



❖ 4. 在MFP52B主选单上，请选择：蓝芽连接



❖ 5. 请选配对模式
(启动自动搜索MFP52B)

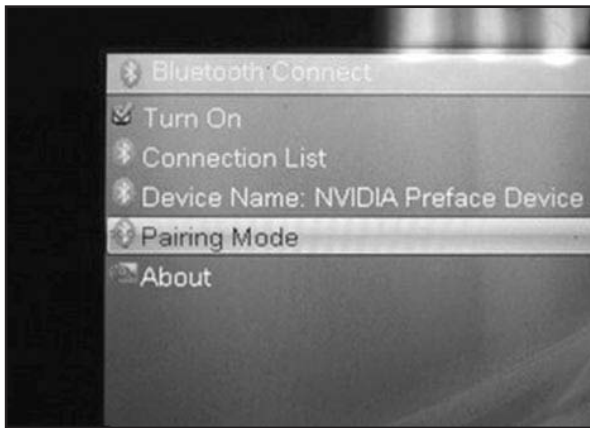

■ 6. 确认MFP52B已准备配对后，点击蓝芽装置安装精灵程序中的”下一步”



- 7. 选择正确的蓝芽装置后（系统可能显示” NVIDIA Preface device”），点击下一步



- 8. 如需输入密码金钥，预设密码为:0000



- 9. 等待系统完成安装sideshow装置驱动程序后，点击”完成”





❖ 10. 轻触确认键确认(请确认步骤九已完成后再执行)

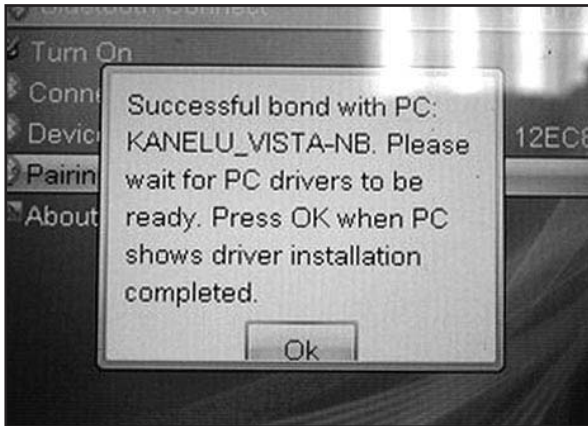

❖ 11. 在MFP52B 主选单中，轻触选单以选择使用者(您的计算机名称)

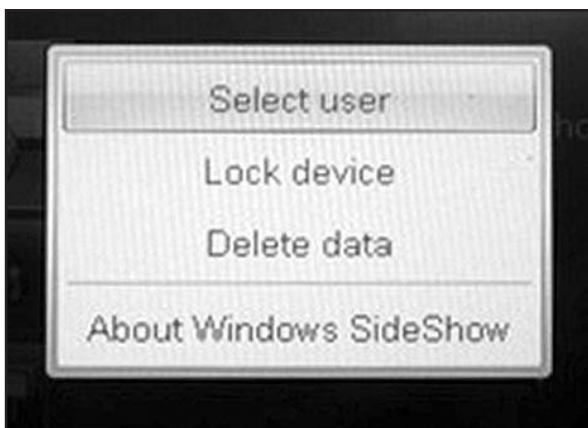

❖ 12. 蓝芽连接完成

(MFP52B 主选单应显示您的计算机名称与蓝芽联机状态)



7. 上传音乐与照片

系统需求: Windows Media Player 10 或以上版本 (Windows XP and Vista)

❖ 1. 从MFP52B主选单上选择” 音乐播放器”



❖ 2. 选择 “切换至同步多媒体”



❖ 3. 此时，同步模式应已启动





- 4. 将MFP52B以内附USB连接线连接至您的计算机，windows系统将会侦测到新增硬件装置(如“NVIDIA device”)并自动为其安装所需的驱动程序。当windows系统通知装置可使用后，请执行windows 多媒体播放程序。新的可移动式多媒体装置(如“NVIDIA M705 5024”)将会出现在windows 多媒体程序右方的小窗口或是左侧的树状目录中



- 5. 音乐与照片档案可以拖曳的方式拖曳至可移动式多媒体装置窗口，当选择完上传档案后，请点击”开始同步”





6. 当同步完成后，请在MFP52B上选择取消



8. 小工具

1. 在控制台中，双击“windows sideshow”图示



2. 选择欲安装的小工具

(请确认在sideshow装置是可执行的)





3. 点击Sideshow装置图标以调整MFP52B的额外设定



9. 屏幕保护

在MFP52B主选单中，点选”锁定装置”功能后，按确认键。如欲解锁，请以相同的次序点击

10. 基本错误排除

1. 触控键无反应

解决方式: 按住确认键13秒以启动硬件恢复默认值，装置将会自动关机。将装置在次开机后将会回复到正常状态。此方式可以解决大多数的稳定性问题

2. 小工具无法勾选

解决方式: 1. 请在MFP52B上确认是否为正确的使用者(请参考上述的蓝牙连接指南)
2. 请确认所选择的小工具可与Sideshow搭配(请与小工具的原创者确认)

3. 蓝牙无法连接 (在配对后)

解决方式: 1. 请再次确认您的计算机与MFP52B是配对的
2. 您也许超过蓝牙传输范围 (蓝牙标准二代距离是10公尺)
3. 在MFP52B主选单上，选择蓝牙连接小工具，并取消” BT Turn on” 选项，再确认一次以重设蓝牙连接
4. 重新启动MFP52B
5. 请将您配对装置自计算机上的蓝牙装置清单中移除，再配对MFP52B



繁体中文

目錄

開機	P83
關機	P83
待機啓動	P83
充電	P83
休眠開關	P83
藍芽連接	P83
上傳音樂與照片	P87
小工具	P88
螢幕保護鎖	P90
基本錯誤排除	P90

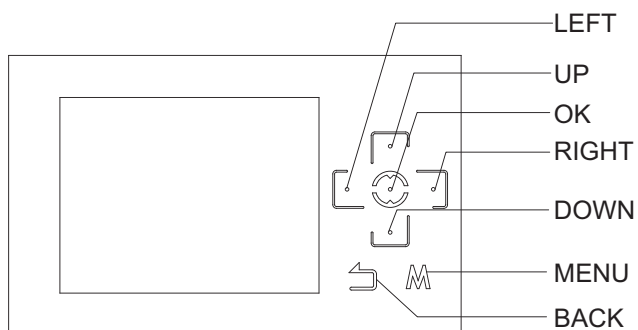



1. 開機
持續輕壓上下左右或確認鍵三秒鐘
2. 關機
持續輕壓確認鍵三秒鐘
3. 待機啓動
觸碰任何鍵
4. 充電
在電腦開機狀態下，使用內附的USB連接線接上MFP52B與電腦USB埠(+5V)進行充電
5. 休眠開關
在MFP52B開機狀態下，持續輕壓返回鍵三秒
6. 連接藍芽裝置
系統需求: Windows Vista, SideShow 平台, 微軟藍芽公用程式, 藍芽接收器或內附傳輸座, Sideshow SPP Profile

1. 將藍芽接收器裝入可用的USB埠，或開啓整合性藍芽連接裝置
- 2. 從控制台開啓微軟藍芽公用程式
- 3. 點擊”新增”以增加新裝置



SilverStone MFP52B Sideshow Unlimited 安裝指南



❖ 4. 在MFP52B主選單上，請選擇：藍芽連接



❖ 5. 請選配對模式
(啓動自動搜索MFP52B)

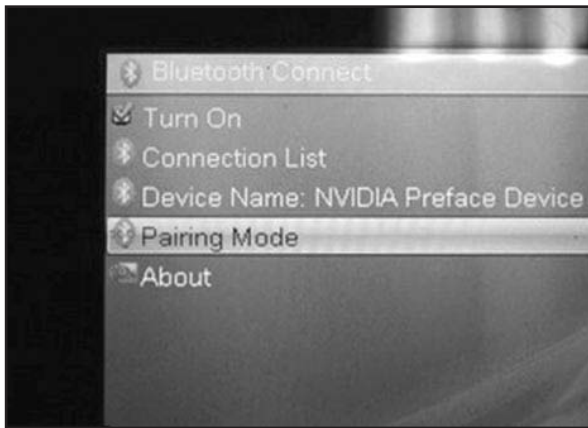

■ 6. 確認MFP52B已準備配對後，點擊藍芽裝置安裝精靈程式中的” 下一步”



SilverStone MFP52B Sideshow Unlimited 安裝指南

- 7. 選擇正確的藍芽裝置後（系統可能顯示” NVIDIA Preface device”），
點擊下一步



- 8. 如需輸入密碼金鑰，預設密碼為:0000



- 9. 等待系統完成安裝sideshow裝置驅動程式後，點擊”完成”



SilverStone MFP52B Sideshow Unlimited 安裝指南



- ❖ 10. 在MFP52上，輕觸確認鍵確認(請確認步驟九已完成後再執行)

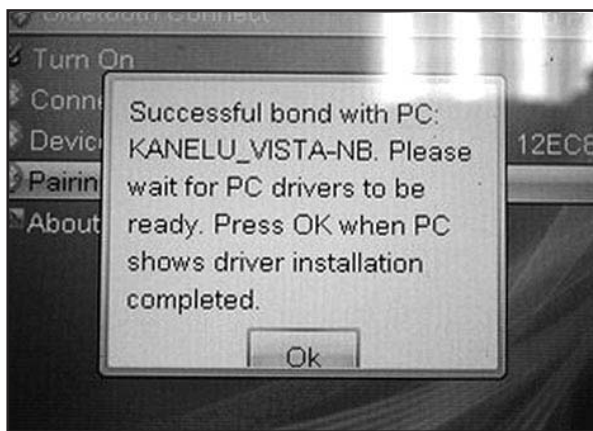

- ❖ 11. 在MFP52B 主選單中，輕觸選單以選擇使用者(您的電腦名稱)

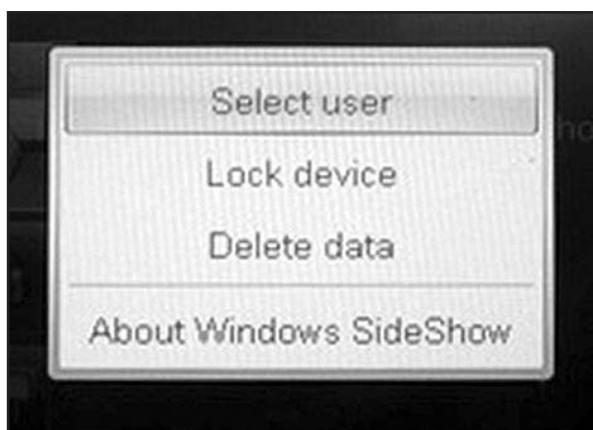

- ❖ 12. 藍芽連接完成

(MFP52B 主選單應顯示您的電腦名稱與藍芽連線狀態)



7. 上傳音樂與照片

系統需求: Windows Media Player 10 或以上版本 (Windows XP and Vista)

❖ 1. 從MFP52B主選單上選擇” 音樂播放器”



❖ 2. 選擇 “切換至同步多媒體”



❖ 3. 此時，同步模式應已啓動



SilverStone MFP52B Sideshow Unlimited 安裝指南



- 4. 將MFP52B以內附USB連接線連接至您的電腦，windows系統將會偵測到新增硬體裝置(如“NVIDIA device”)並自動為其安裝所需的驅動程式。當windows系統通知裝置可使用後，請執行windows 多媒體播程式。新的可移動式多媒體裝置(如“NVIDIA M705 5024”)將會出現在windows 多媒體程式右方的小視窗或是左側的樹狀目錄中



- 5. 音樂與照片檔案可以拖曳的方式拖曳至可移動式多媒體裝置視窗，當選擇完上傳檔案後，請點擊”開始同步”





6. 當同步完成後，請在MFP52B上選擇取消



8. 小工具

1. 在控制台中，雙點擊 “windows sideshow” 圖示



2. 選擇欲安裝的小工具

(請確認在sideshow裝置是可執行的)



Execute commands in Windows

Execute commands on MFP52

SilverStone MFP52B Sideshow Unlimited 安裝指南



3. 點擊Sideshow裝置圖示以調整MFP52B的額外設定



9. 螢幕保護

在MFP52B主選單中，點選”鎖定裝置”功能後，按確認鍵。
如欲解鎖，請以相同的次序點擊

10. 基本錯誤排除

1. 觸控鍵無反應

解決方式：按住確認鍵13秒以啟動硬體恢復預設值，裝置將會自動關機。

將裝置在次開機後將會回復到正常狀態。此方式可以解決大多數的穩定性問題

2. 小工具無法勾選

解決方式：1. 請在MFP52B上確認是否為正確的使用者（請參考上述的藍芽連接指南）

2. 請確認所選擇的小工具可與Sideshow搭配（請與小工具的原創者確認）

3. 藍芽無法連接（在配對後）

解決方式：1. 請再次確認您的電腦與MFP52B是配對的

2. 您也許超過藍芽傳輸範圍（藍芽標準二代距離是10公尺）

3. 在MFP52B主選單上，選擇藍芽連接小工具，並取消” BT Turn on” 選項，
再確認一次以重設藍芽連接

4. 重新啟動MFP52B

5. 請將您配對裝置自電腦上的藍牙裝置清單中移除，再配對MFP52B

SilverStone Technology Co., Ltd.

www.silverstonetek.com

support@silverstonetek.com

Issue date: April, 2008

No.:G1120